

LÄTT B: A-D LÄTT A: A-E. MSV: A-F

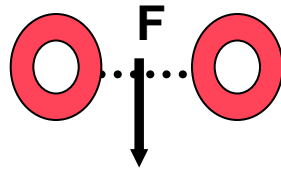

IN/OUT

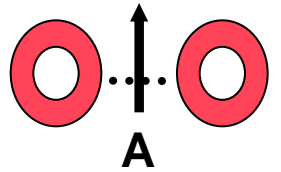
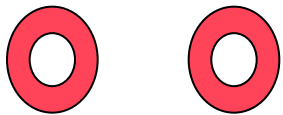
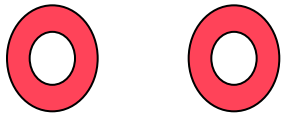
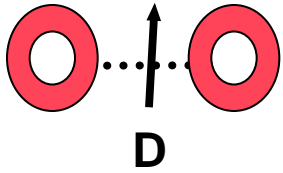
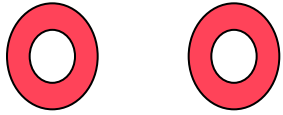
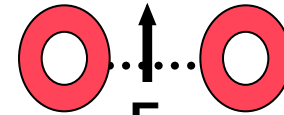
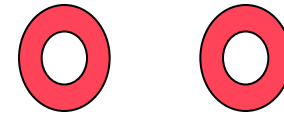

H2: Precisionsbana

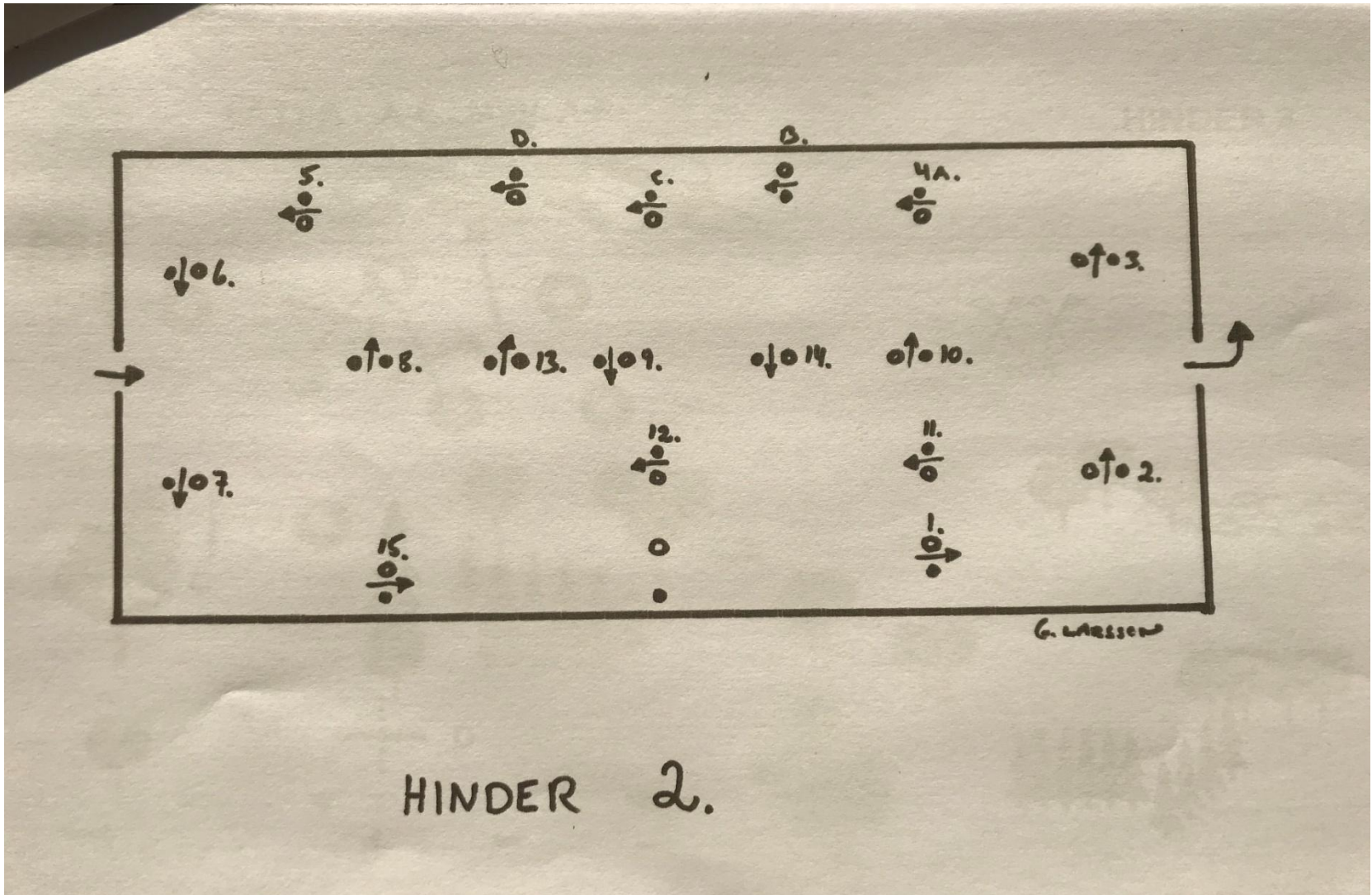

LÄTT B: A-C LÄTT A: A-E. MSV: A-F

HINDER 3

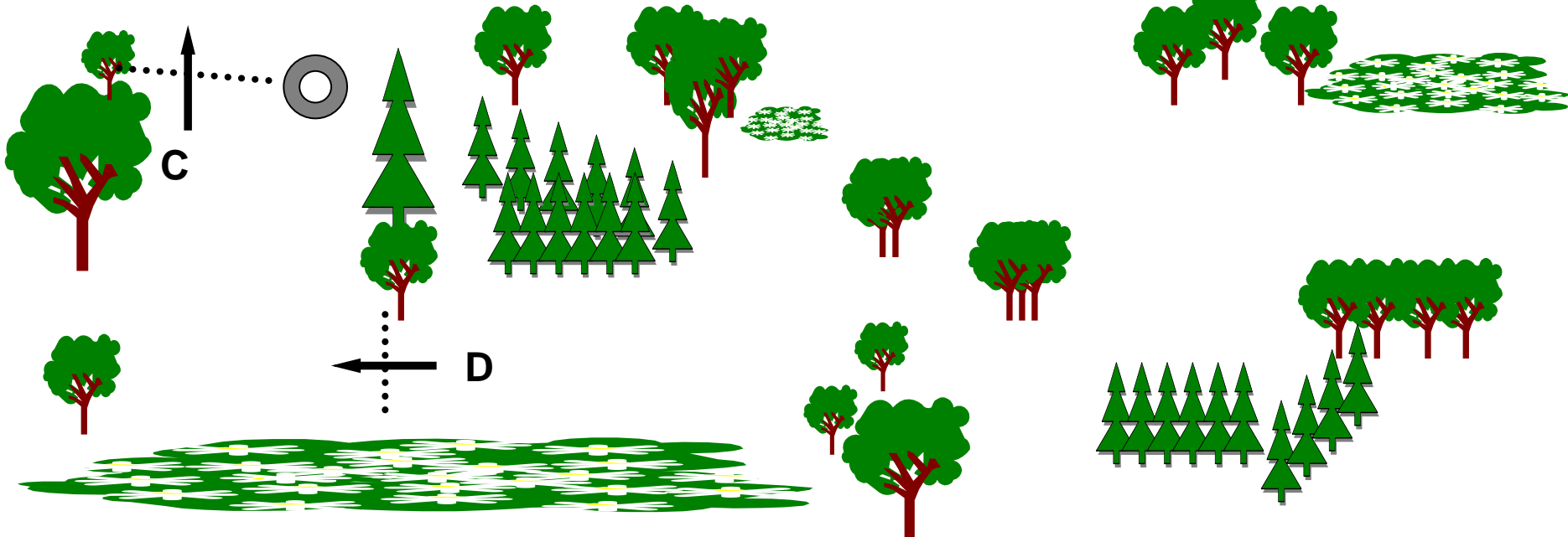
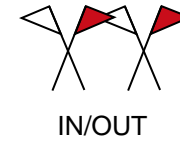
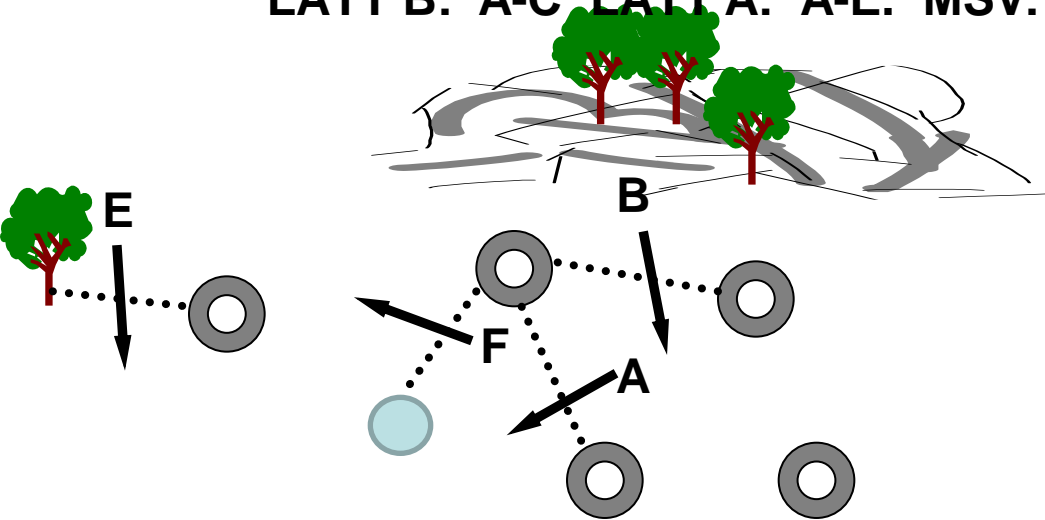

MSV: A-F

HINDER 4

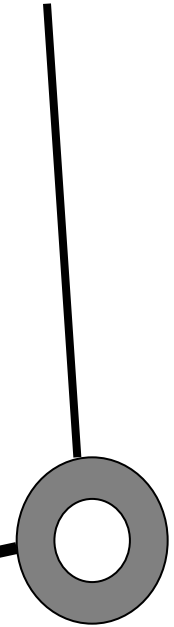
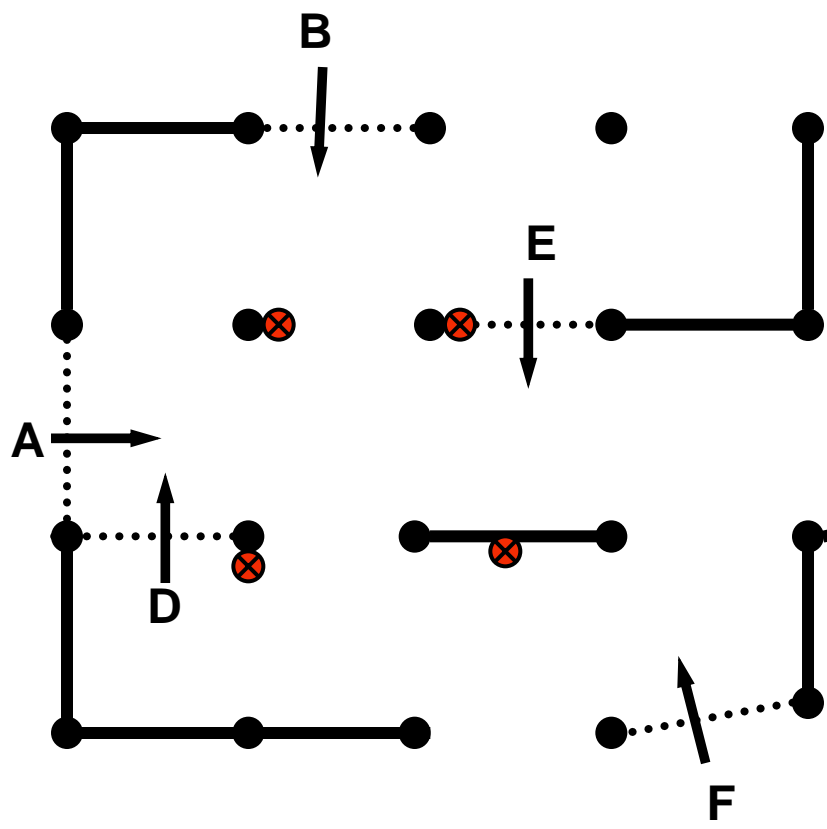
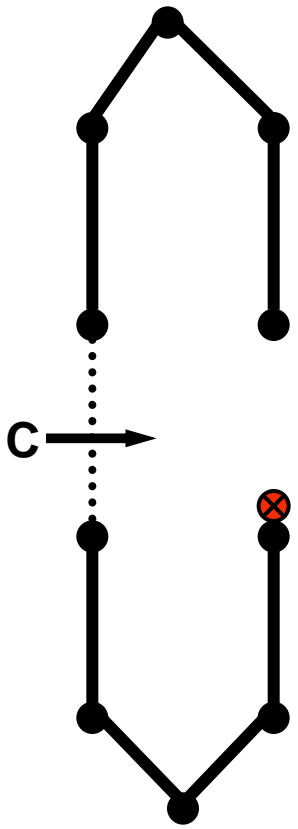
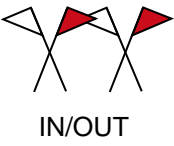

⊗ Rivbar del = 5 st.

LÄTT B: A-D. LÄTT A: A-E. MSV: A-F

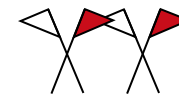

HINDER 5

IN/OUT

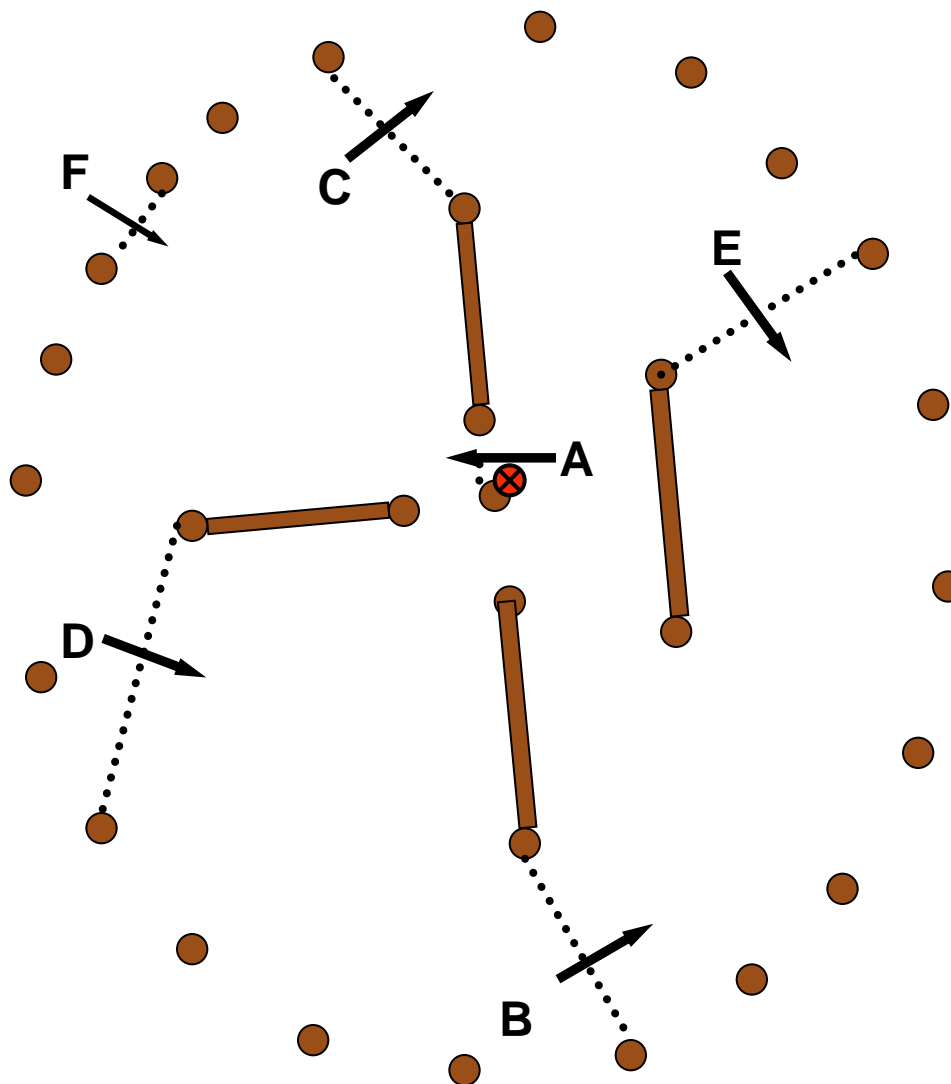

⊗ Rivbar del =1